

# TUROLIGHT®

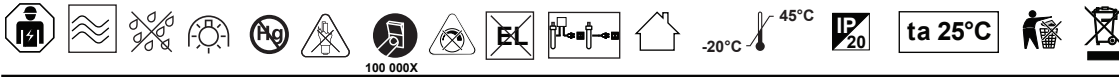

## Type A+B installation

1. Make sure the circuit breaker that supplies power to the fixture is turned off.
2. Remove trim and existing CFL lamp(s) from the recessed fixture.
3. Directly load the LED LAMPS into the housing and take the lamp into G24Q socket.
4. Plug and Turn on the lamp.
5. Please make sure turn off the power when operate the CCT switch.

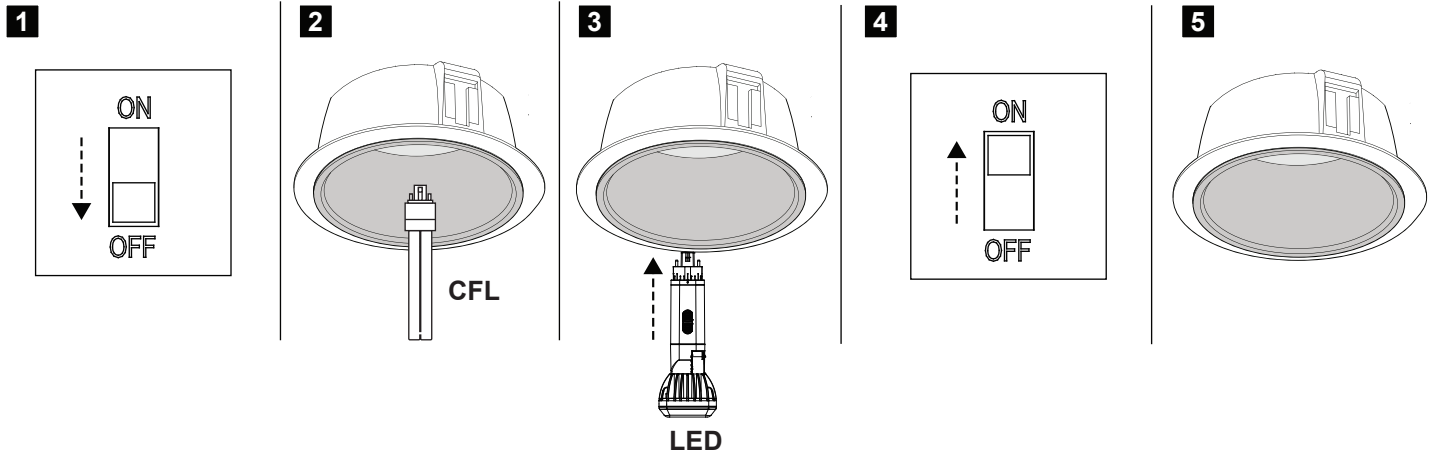

### Cap extendable

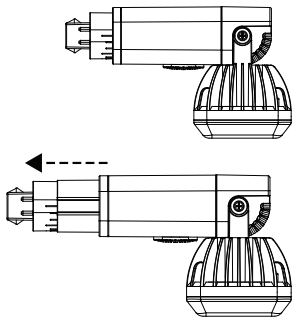

### Cap 90° Rotate

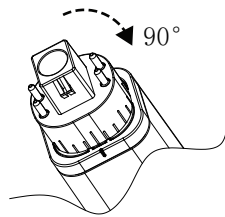

### Vertical or horizontal installation.

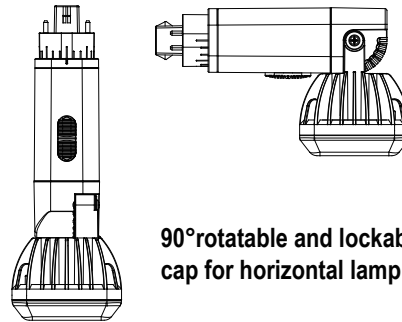

90° rotatable and lockable cap for horizontal lamp

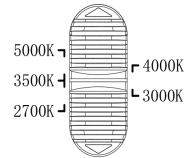

5 Color temperature selectable

### Model Number

VIV-PL-HY-9W-5CCT-G24q-DUO  
VIV-PL-HY-16W-5CCT-G24q-DUO

### ANSI Designations of target lamps

26W/8T4/Q/G24Q-3  
42W/7T4/M/GX24Q-4

	MODEL NUMBER	VIV-PL-HY-9W-5CCT-G24q-DUO VIV-PL-HY-16W-5CCT-G24q-DUO
	DIAMETER	8 INCH /10 INCH
	HEIGHT	4.5 INCH

	MODEL NUMBER	VIV-PL-HY-9W-5CCT-G24q-DUO VIV-PL-HY-16W-5CCT-G24q-DUO
	DIAMETER	5 INCH/6 INCH
	HEIGHT	8 INCH

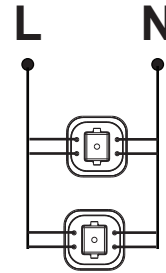
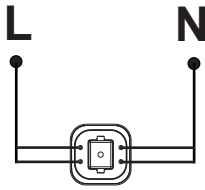

Compatible ECG

1a

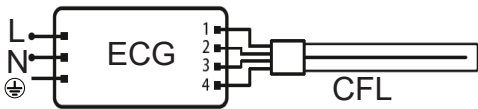

2a

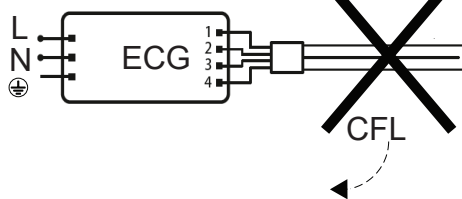

3a

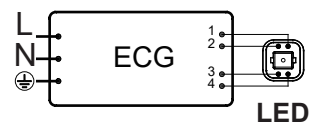

1b

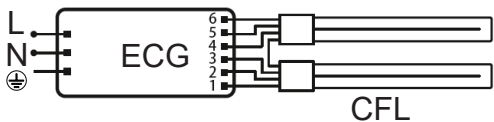

2b

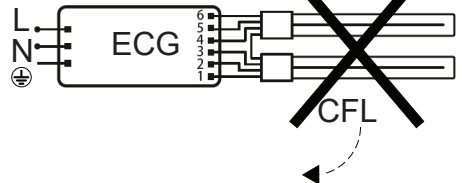

3b

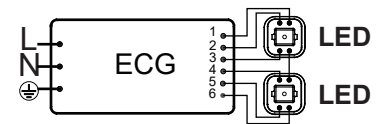

**CAUTION**

1. CAUTION – RISK OF FIRE. IF THE LAMP OR LUMINAIRE EXHIBITS UNDESIRABLE OPERATION (BUZZING, FLICKERING, ETC.), IMMEDIATELY TURN OFF POWER, REMOVE LAMP FROM LUMINAIRE AND CONTACT MANUFACTURER.
2. WARNING – RISK OF FIRE OR ELECTRIC SHOCK. THIS PRODUCT MUST BE INSTALLED IN ACCORDANCE WITH THE APPLICABLE INSTALLATION CODE BY A PERSON FAMILIAR WITH THE CONSTRUCTION AND OPERATION OF THE PRODUCT AND THE HAZARDS INVOLVED.
3. WARNING – RISK OF FIRE OR ELECTRIC SHOCK. INSTALL THIS KIT ONLY IN LUMINAIRES THAT HAVE THE CONSTRUCTION FEATURES AND DIMENSIONS SHOWN IN THE PHOTOGRAPHS AND/OR DRAWINGS.
4. DO NOT MAKE OR ALTER ANY OPEN HOLES IN AN ENCLOSURE OF WIRING OR ELECTRICAL COMPONENTS DURING KIT INSTALLATION.
5. WARNING – TO PREVENT WIRING DAMAGE OR ABRASION, DO NOT EXPOSE WIRING TO EDGES OF SHEET METAL OR OTHER SHARP OBJECTS.
6. INSTALLERS SHOULD NOT DISCONNECT EXISTING WIRES FROM LAMPHOLDER TERMINALS TO MAKE NEW CONNECTIONS AT LAMPHOLDER TERMINALS. INSTEAD INSTALLERS SHOULD CUT EXISTING LAMPHOLDER LEADS AWAY FROM THE LAMPHOLDER AND MAKE NEW ELECTRICAL CONNECTIONS TO LAMPHOLDER LEAD WIRES BY EMPLOYING APPLICABLE CONNECTORS.
7. INSTALLERS SHOULD EXAMINE ALL PARTS THAT ARE NOT INTENDED TO BE REPLACED BY THE RETROFIT KIT FOR DAMAGE AND REPLACE ANY DAMAGED PARTS PRIOR TO INSTALLATION OF THE RETROFIT KIT.
8. WARNING – RISK OF FIRE. INPUT RATINGS MAY NEED TO BE DETERMINED BASED ON ANY CONFIGURATION(S) PERMITTED BY THE INSTALLATION INSTRUCTIONS. REGARDLESS OF THE CONFIGURATION(S) OF THE RETROFIT KIT, THE INPUT RATINGS OF THE OVERALL RETROFIT KIT SHALL NOT EXCEED THE MARKED INPUT RATINGS OF THE HOST LUMINAIRE.
9. SUITABLE FOR DAMP LOCATIONS. SUITABLE FOR OPERATION IN LUMINAIRES WITH AMBIENT NOT EXCEEDING 45°C.
10. PRIOR TO INSTALLATION, REVIEW ALL ENVIRONMENTAL DESIGNATION LOCATIONS IN THE RETROFIT KIT INSTALLATION INSTRUCTIONS. ONLY INSTALL IN DAMP OR WET LOCATIONS IF SO INDICATED IN THE INSTALLATION INSTRUCTIONS.
11. THE RETROFIT KIT IS ACCEPTED AS A COMPONENT OF A LUMINAIRE WHERE THE SUITABILITY OF THE COMBINATION SHALL BE DETERMINED BY AUTHORITIES HAVING JURISDICTION. PRODUCT MUST BE INSTALLED BY A QUALIFIED ELECTRICIAN IN ACCORDANCE WITH THE APPLICABLE AND APPROPRIATE ELECTRICAL CODES. THE INSTALLATION GUIDE DOES NOT SUPERSEDE LOCAL OR NATIONAL REGULATIONS FOR ELECTRICAL INSTALLATIONS.
12. THIS LAMP ONLY OPERATES ON ELECTRONIC BALLASTS. IF LAMP DOES NOT LIGHT WHEN THE LUMINAIRE IS ENERGIZED, REMOVE LAMP FROM LUMINAIRE AND CONTACT LAMP MANUFACTURER OR QUALIFIED ELECTRICIAN.
13. EXAMINE LUMINAIRE FOR DAMAGE BEFORE INSTALLING LED LAMP. IF LAMP HOLDERS OR OTHER PARTS ARE VISIBLY DAMAGED CONTACT A SERVICE PERSON.
14. DO NOT MIX FLUORESCENT AND LED LAMPS IN THE SAME LUMINAIRE UNLESS BALLAST IS MARKED FOR THIS PURPOSE.
15. THIS DEVICE IS NOT INTENDED FOR USE WITH EMERGENCY EXITS.
16. IF INSTALLING THIS LAMP IN A PRE-HEAT LUMINAIRE, REMOVE THE AUTOMATIC STARTERS FROM THEIR HOLDERS BEFORE INSTALLING LAMP.