

# Installation Instruction

Infrared Fixture Integrated Sensor For High Bay Light

Applicable models:  
TL-2052+

# Installation Instruction

Infrared Fixture Integrated Sensor For High Bay Light

Applicable models:  
TL-2052+



## INTRODUCTION

The product is a new Energy-saving switch, it adopts good sensitivity detector, integrated circuit and SMT. It gathers automatism, convenient safe, Energy-saving and practical functions. It utilizes the infrared energy from human as control-signal source, it can start the load at once when one enters detection field. It is easy to install and used widely, possessing the function of power show and detection show.

## SPECIFICATIONS

Power supply	120-347VAC 50/60Hz
Maximum load @ -40°F ~ +167°F (-40°C ~ +75°C)	LED - 800W@120V/1200W@277V/1500W@347V Standard Ballast -800W@120V/1200W@277V/1500W@347V Fluorescent Ballast - 800W@120V/1200W@277V/1500W@347V
Lens L5	Max.detection radius 30ft;Max.mounting height 25ft
Lens L6	Max.detection radius 30ft;Max.mounting height 40ft
Time setting	10sec.-20min.(adjustable)
Light-control	☾ or ☀ (light sensor disable)
Humidity	Max. 95% RH
Temperature	-40°F ~ +167°F (-40°C ~ +75°C)

## NOTE

**NOTE:** Warm up time is 40seconds. After the sensor connects input power first time, the light will keep on 40seconds,then go off to work normally.

**NOTE:** Factory Default Setting: 100% sensitivity, Hold on time: 10seconds, daylight sensor is disable.

**NOTE:** Any setting changed by DIP Switch, the led light that sensor connect will on/off as confirm.

\* Not applicable for TL-2052+

## SENSOR INFORMATION

### L5 Lens \*

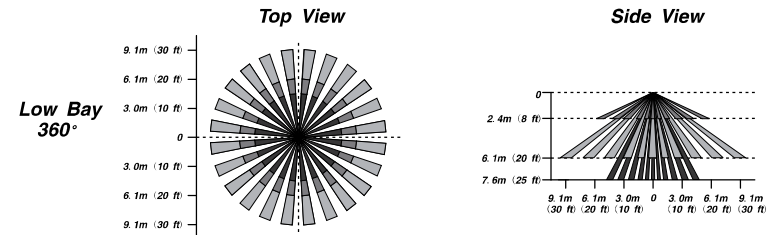

### L6 Lens

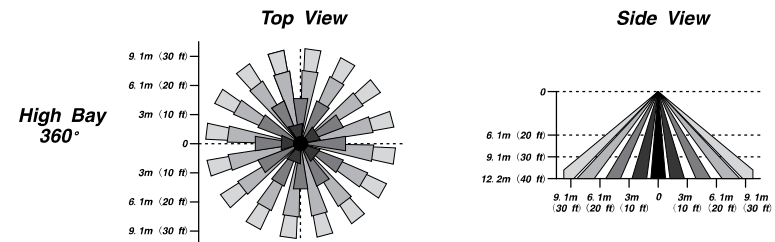

## TL-2052+ MOUNTED TO LINEAR HIGH BAY LIGHT.

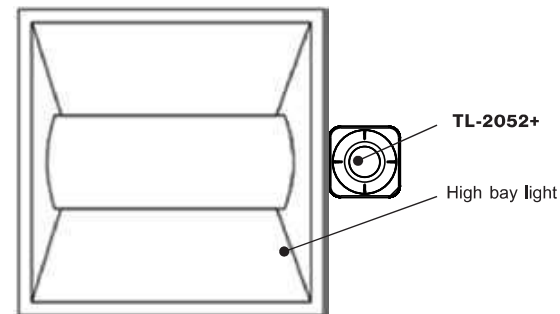

\* Not applicable for TL-2052+

# Installation Instruction

Infrared Fixture Integrated Sensor For High Bay Light

Applicable models:  
TL-2052+

## PARAMETER SETTING BY DIP SWITCH

Shown as chart below : By setting the 1 to set the detection range of products , by setting 2,3,4,5,6,7,8 to set the delay time of products, by setting the 9, 10 to set the light-control of products.

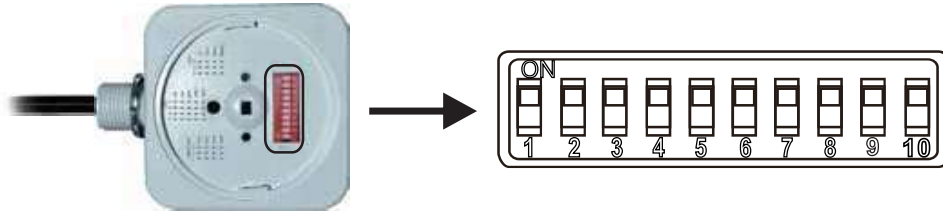

### Detection Range Setting (sensitivity)

Detection range is the term used to describe the radius of the more or less circular detection zone produced on the ground after mounting the sensor light at a height of 40ft, pull switch to the ON position as "↑", pull switch to the OFF position as "↓", switch location and detection range of the corresponding table is as follows:

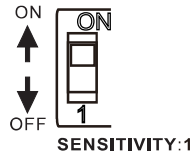

SENSITIVITY	
↑	100%
↓	50%

### Hold Time Setting

The light can be set to stay ON for any period of time between approx, 10sec and a maximum of 20min. Any movement detected before this time elapse will re-start the timer. It is recommended to select the shortest time for adjusting the detection zone and for performing the walk test. Pull switch to the ON position as "↑", pull switch to the OFF position as "↓", switch location and hold time of the corresponding table is as follows:

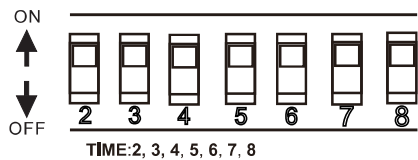

TIME	
↑	10S
↓	30S
↓	60S
↓	90S
↓	3Min
↓	5Min
↓	20Min

# Installation Instruction

Infrared Fixture Integrated Sensor For High Bay Light

Applicable models:  
TL-2052+

## Light-control Setting

The chosen light response threshold can be infinitely from approx. pull switch to the ON position as "↑", pull switch to the OFF position as "↓", switch location and light-control of the corresponding table is as follows:

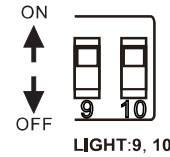

LIGHT	
↑	9
↓	10
↓	☾ (light sensor disable)
↑	☀ (light sensor disable)

## WIRING DIAGRAMS

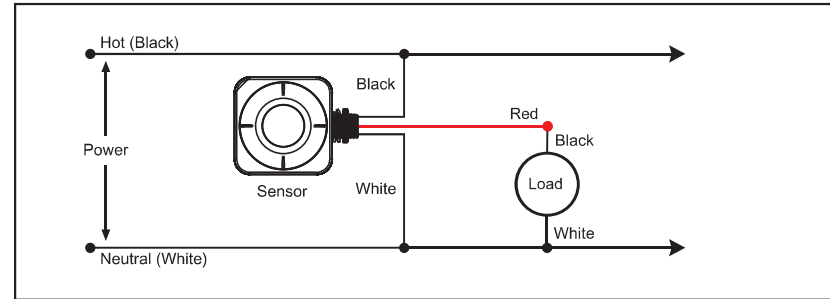

**WARNING**  
TURN THE POWER OFF AT THE CIRCUIT BREAKER BEFORE INSTALLING THE SENSOR.

**AVERTISSEMENT**  
COUPER L'ÉLECTRICITÉ AU DISJONCTEUR AVANT D'INSTALLER LE CAPTEUR.

